

Article number: 20286B45B42T2BL

Description: E+G Swivel clamp connector joint
GN286-B45-B42-T-2-BL

Measures

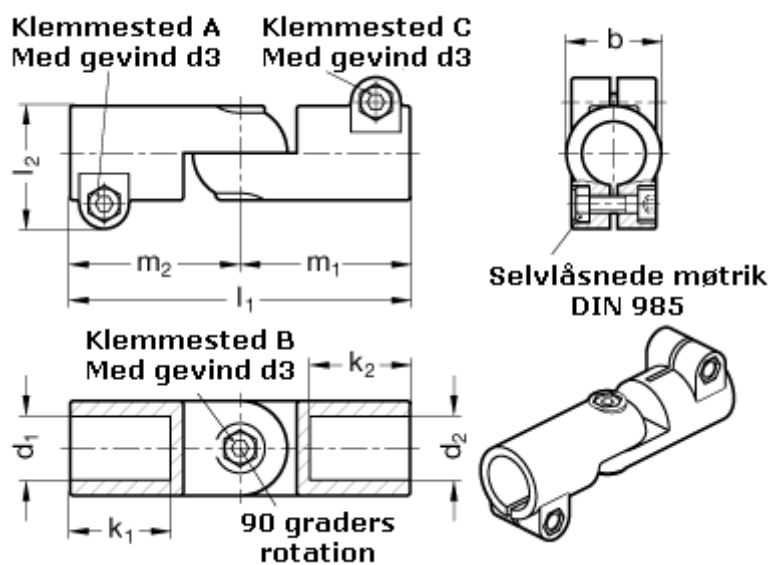

$b = 65$	$m_1 = 115$
$d_1 = B45$	$m_2 = 115$
$d_2 = B42$	
$d_3 = M10$	
$k_1 = 74.0$	
$k_2 = 74.0$	
$l_1 = 230$	
$l_2 = 77.5$	